



NextFEM Designer
Section Analyzer manual

Version 2.4

© NextFEM 2015-2024

Contents

Chapter 1 About Section Analyzer	3
Installing NextFEM Designer	3
License activation	3
User interface.....	3
Chapter 2 Section properties	4
Composite sections.....	5
Chapter 3 Strength calculator	8
Checking FRP reinforcements in concrete sections	10
Flexural reinforcement with FRP	11
Shear reinforcement with FRP	11
Confining with FRP	12
Flexural reinforcement with FRCM.....	14
Shear reinforcement with FRCM	14
Confinement with FRCM	14
Error codes	15
License Terms	16

Chapter 1

About Section Analyzer

NextFEM Section Analyzer is an easy-to-use program for calculating strength of any transversal section, starting from material properties, geometry and design forces. This program supports:

- Reinforced Concrete (RC) sections, with steel reinforcements or strands
- Steel and aluminium alloy sections
- Timber section, with or without reinforcing steel
- Steel-concrete composite sections.

Installing NextFEM Designer

NextFEM designer is designed to work with Windows 7 SP1 or above and it is available for 32 or 64 bit Windows versions.

License activation

To activate the program you must be connected to the Internet at the first run. For the licensed installation, please refer to the command *?/License...*

User interface

La finestra principale del programma è mostrata in figura seguente. Le funzionalità principali sono le seguenti:

- In Add section box there are commands to add planar sections (equivalent width of 1m) or beam transversal sections, from the bottom menu. Sections added are visible in the table above.
- The command Edit properties allows to modify the selected section, by adding shapes or importing them from DXF drawings
- The button Strength calculator shows the mask for the checking the selected section.

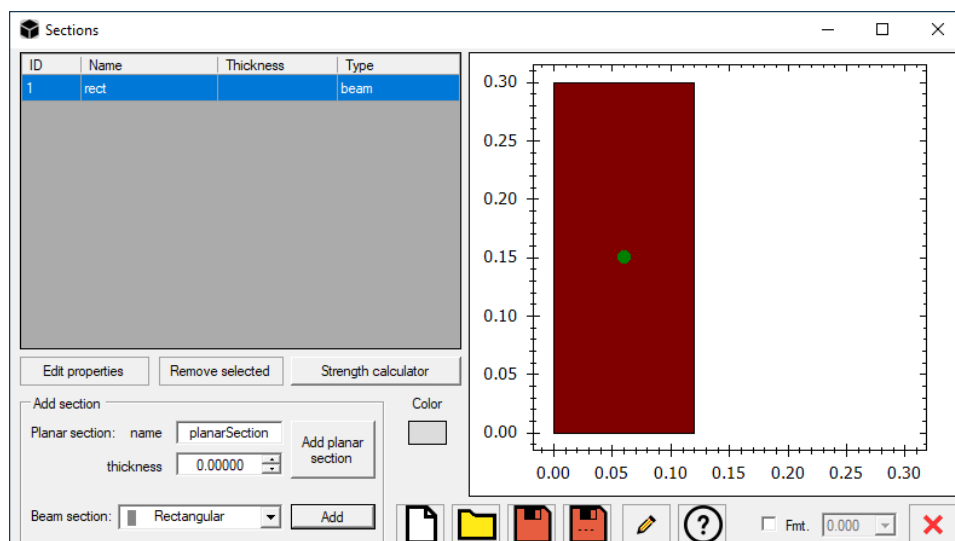

Chapter 2

Section properties

The built-in beam sections available are:

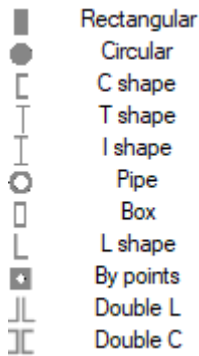

Further section shapes are available: Omega and cold-formed non-thin-walled C shapes, that can be set from inside the section properties.

Other custom libraries can be present in this list. For each of them, the following mask will be displayed to allow selection. Several libraries for steel sections are included in the program.

Add by section type

Name	Code	h [mm]	b [mm]	tw [mm]	tf [mm]	r [mm]	A [cm ²]	Jz [cm ⁴]	Wez [cm ³]	Wpz [cm ³]	iz [cm]	Avz [cm ²]	Jy [cm ⁴]	Wey [cm ³]	Wpy [cm ³]	iy [cm]	Type
HE 1...	UNI	91	100	4.2	5.5	12	15.6	236.5	52.0	58.4	3.89	6.15	92.06	18.41	28.44	2.43	Dou...
HE 1...	UNI	96	100	5	8	12	21.2	349.2	72.8	83.0	4.06	7.56	133.81	26.76	41.14	2.51	Dou...
HE 1...	UNI	100	100	6	10	12	26.0	449.5	89.9	104.2	4.16	9.04	167.27	33.45	51.42	2.53	Dou...
HE 1...	UNI	120	106	12	20	12	53.2	1142.6	190.4	235.8	4.63	18.04	399.15	75.31	116.31	2.74	Dou...
HE 1...	UNI	109	120	4.2	5.5	12	18.6	413.4	75.8	84.1	4.72	6.90	158.81	26.47	40.62	2.93	Dou...
HE 1...	UNI	114	120	5	8	12	25.3	606.2	106.3	119.5	4.89	8.46	230.90	38.48	58.85	3.02	Dou...
HE 1...	UNI	120	120	6.5	11	12	34.0	864.4	144.1	165.2	5.04	10.96	317.52	52.92	80.97	3.06	Dou...
HE 1...	UNI	140	126	12.5	21	12	66.4	2017.6	288.2	350.6	5.51	21.15	702.77	111.55	171.63	3.25	Dou...
HE 1...	UNI	128	140	4.3	6	12	23.0	719.5	112.4	123.8	5.59	7.92	274.83	39.26	59.93	3.45	Dou...
HE 1...	UNI	133	140	5.5	8.5	12	31.4	1033.1	155.4	173.5	5.73	10.12	389.32	55.62	84.85	3.52	Dou...
HE 1...	UNI	140	140	7	12	12	43.0	1509.2	215.6	245.4	5.93	13.08	549.67	78.52	119.78	3.58	Dou...
HE 1...	UNI	160	146	13	22	12	80.6	3291.4	411.4	493.8	6.39	24.46	1144...	156.76	240.51	3.77	Dou...
HE 1...	UNI	148	160	4.5	7	15	30.4	1282.9	173.4	190.4	6.50	10.38	478.73	59.84	91.36	3.97	Dou...

Please select a section from the list

Pick Close

To see the properties (area and moments of inertia) of the inserted sections select a section and press the *Edit properties* button. This mask allows also to import a section from DXF file and define a section by points or by composing single figures.

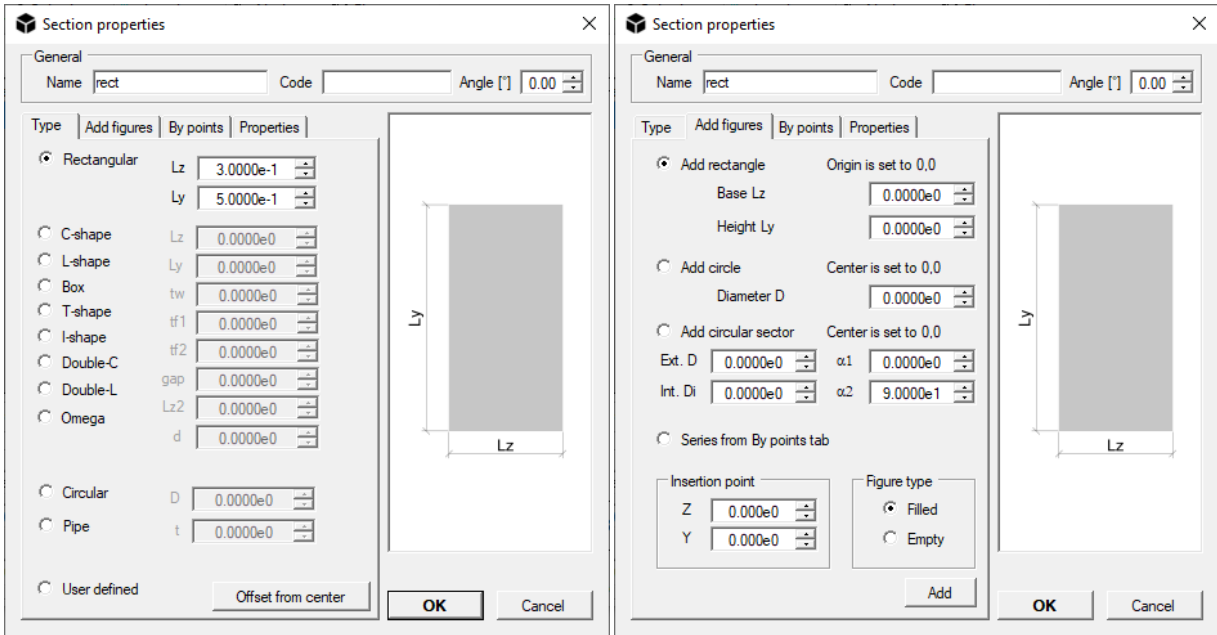

⚠ WARNING: it is strongly advised to insert units consistent with the initial choices (see *Edit > Set units*).

In the Properties mask it is possible to specify the design properties of the section to be used during checking.

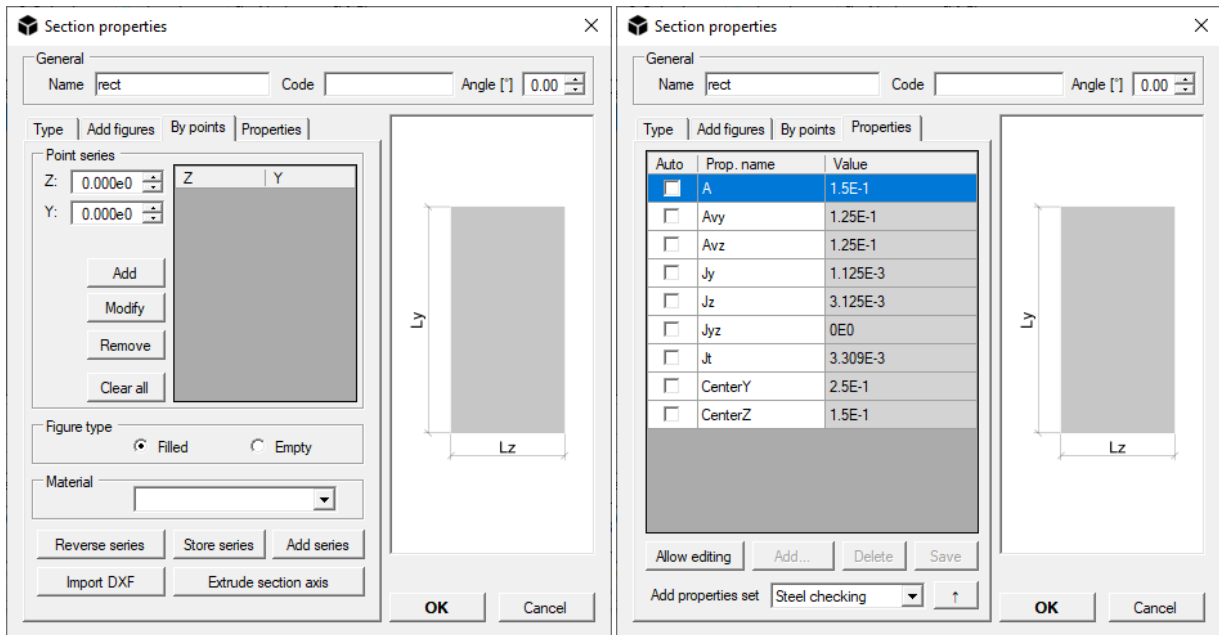

⚠ WARNING: by changing the sectional properties, the section will be converted in "Custom" type. Such operation is not reversible.

Composite sections

The support for composite sections includes:

- Beams with slab like in figure (a) and
- Columns with coincident centres of gravity (b).

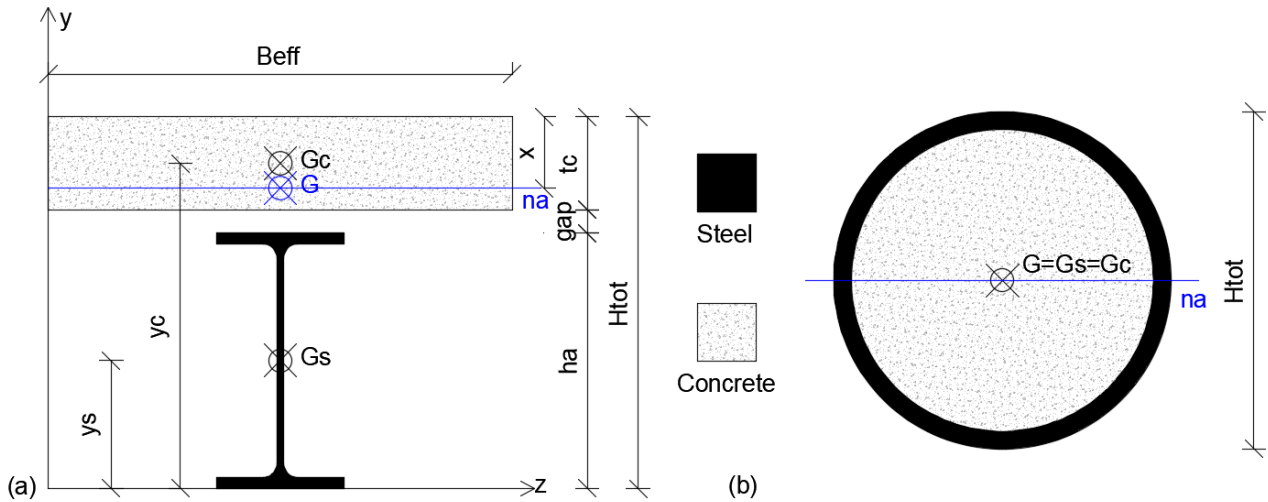

A composite section is automatically detected when:

- Two or more filled figures, one of them associated to a steel material and one to a concrete material;
- Properties of the composite section are defined inside the mask *Section properties / Properties* in order to distinguish a beam or a column section.

! WARNING: The effective width of the section *Beff* must be evaluate by the user as per current code of practice.

The stiffness of beam elements having such sections is evaluated as follows. With subscript *s*, steel properties are described, while the ones related to concrete have the subscript *c*.

For beams, the moment of inertia for positive bending around the elastic neutral axis *na* is calculated as:

$$I_{z1} = I_{zs} + A_{zs} \cdot (H_{tot} - y_s - x)^2 + \frac{I_{zc}}{n} + \frac{A_{zc}}{n} (x - H_{tot} + y_c)^2$$

$$\text{with } n = \frac{E_s}{E_c} \text{ and } x = H_{tot} - \frac{n \cdot A_{zs} \cdot y_s + A_{zc} \cdot y_c}{n \cdot A_{zs} + A_{zc}}$$

The moment of inertia of the section for negative bending around the plastic neutral axis is equal to the inertia given by the steel section, as the concrete part is considered as cracked.

As a whole, bending stiffness is estimated as per EC4 and as a function of the factors *Mpos* and *Mneg* which can be changed in the "Properties" input mask (figure a).

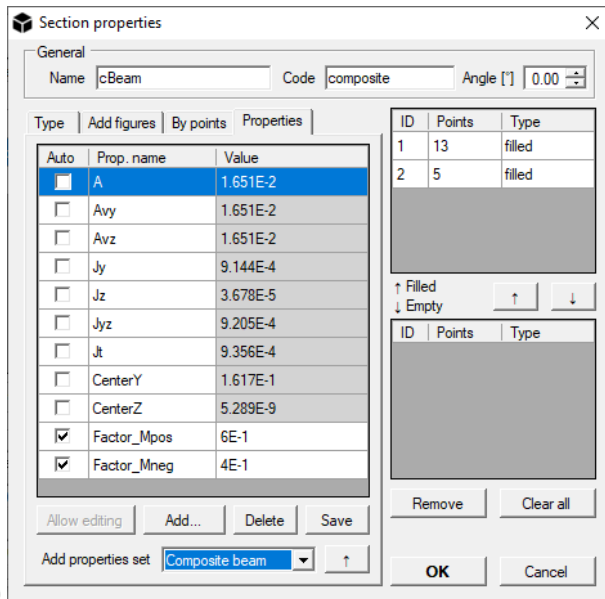

(a)

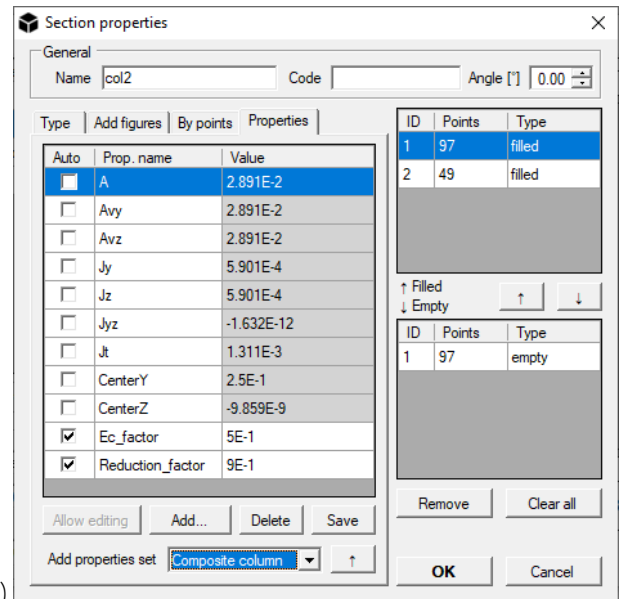

(b)

Hence, the resulting bending stiffness is:

$$I_z = f_{Mpos} \cdot I_{z1} + f_{Mneg} \cdot I_{zs}$$

The remaining properties for the beam section are all calculated by dividing the concrete contribution by n .

For composite columns, once the factors E_c and R have been specified in the "Properties" mask (figure b), the inertial properties of the section are calculated as follows:

$$I_z = R \cdot \left(I_{zs} + \frac{I_{zcc}}{n} \right); I_y = R \cdot \left(I_{ys} + \frac{I_{ycc}}{n} \right); I_{yz} = R \cdot \left(I_{yzs} + \frac{I_{yzcc}}{n} \right);$$

$$\text{with } n = \frac{E_s}{f_{Ec} E_c}$$

The remaining properties are all calculated by dividing the concrete contribution by n .

Chapter 3 Strength calculator

By the *Strength calculator* button it is possible to define the rebar in a RC section and to evaluate its flexural strength.

The screenshot shows the 'Calculate section strength' software interface. It includes a 'Define material properties' section with 'Base material' set to 'C25/30'. The 'Rebar position' section contains a table with columns for X, Y, Area, and Mater. The 'Design forces' section has input fields for Compression N, Moment Mz, and Moment My. The 'Temperature' section has options for Case and Time. The 'Results' section displays a table with columns for Neutral axis angle, N.a. distance from maxC, N.a. distance from maxT, Max stress in base material, Max base mat. strain, and Max rebar stress. The 'Options' section includes 'Concrete non-linear behaviour' (Parabola-rectangle), 'Allow concrete tensile strength' (checkbox), and 'Bilinear hardening ratio' and 'Strand' input fields. A central plot shows a cross-section with rebar positions, and a right-side plot shows the My-Mz interaction diagram for N=0.0 [N].

In *Define material properties* the base material is specified.

The box *Rebar position* can be used to specify the rebar coordinates (eventually of rectangular shape by checking the option *Rect. rebar* and by specifying the base dimension of the plate in *Rect. base*). The rebar coordinates are input on the base of the section local coordinate system, by specifying the diameter and the associated material (that can be **set or added by the command "..."**). **The available materials should be customized by modifying or adding *.nfm files in *data/design* subfolder in the software installation directory.**

In order to insert strands for prestressed RC sections, it is possible to input the initial strand stress by activating the *Strand σ* option and by inputting the stress in consistent dimensions.

To obtain the resistant values of the section, specify the *Design forces* in the required units. By selecting the *Elastic* option, the response of the section is computed with elastic materials. By selecting *Plastic*, elastic-perfectly plastic laws are used for material behaviour. In the *Results* box, the results of the performed computation are reported, linked to the overlying graphs.

The window allows also resistant domains calculations reduced by thermal action. The software will compute the strengths parameters of the section at the selected instant of time and thermal case, on the base of strengths reductions laws for mechanical and resistant features of base material and rebar, if present.

The available options in this mask are:

- *Concrete non-linear behaviour* allows to choose between parabola-rectangle and bilinear material behaviour for the concrete material. If a simple rectangular or circular section are present, the *Confined concrete* option is available in this menu, allowing to consider the confined part of the section inside stirrups. In this case, data in *Stirrups* tab are required. Spirals are not supported.

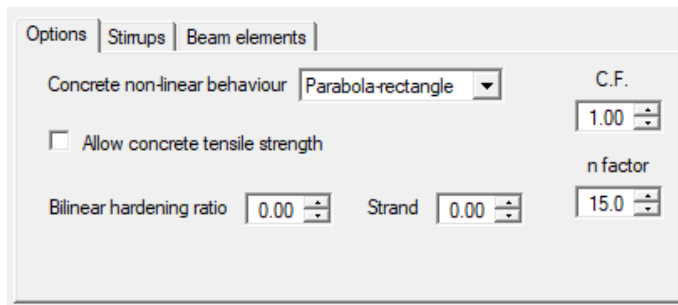

- *Allow concrete tensile strength* can be enabled to activate the contribution of tensile strength of the base material;
- *Bilinear hardening ratio* allows to specify the ratio between the plastic branch of rebar and their elastic modulus. In case of Steel or Aluminium base material, it specifies the hardening ratio to be used.
- *Steel class section* sets the class of the section in case of Steel or Aluminium base material, i.e. if the section can be calculated in plastic field or not.
- *Confidence Factor (C.F.)* sets the confidence factor for strength of base material and rebar.
- *n factor* specifies the value of the homogenization factor (modular ratio between steel and concrete). The default is 15.

Stirrups tab helps to define the stirrups for the current section and to obtain a resisting strength for both direction of the section.

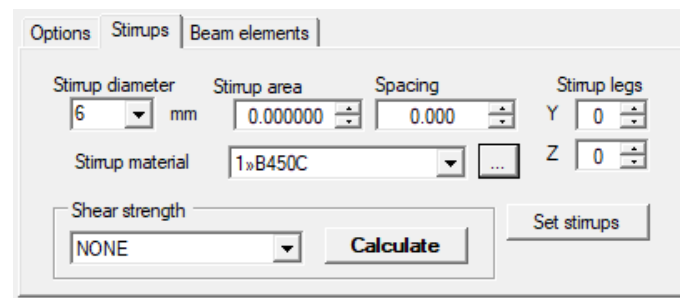

The "Other Reinf." button (Other Reinforcement) allows you to apply shear or FRP confinement reinforcement to the section for verification with this data (shear verification only for rectangular and T-sections):

Shear strip width	bf strip width
Shear strip spacing	pf shear strip pitch
Shear strip angle [°]	stripes angle to horizontal in °
Shear strip material ID	FRP material ID for shear reinforcement
Shear strip thickness [mm]	t strip thickness
Shear strip height [mm]	U-shaped winding height in mm
Confinement strip spacing (-1 for continuous)	-1 if complete winding - pf if U-shaped winding (bf<pf)
Shear strip height along base [mm]	strip width on section base (whole base for U-shaped or complete windings)
Width of the side hosting FRP strip [mm]	width of base section in mm

FRP strips are anchored (skip strip detachment) [0/1]	anchoring the strips
Edge curvature radius for FRP confinement [mm]	radius of curvature of section edges
Complete wrapping in FRP for shear res. [0/1]	1 if complete winding shear reinforcement 0 otherwise

Export Results contains options to:

- plot the tension in the reinforcement bars,
- to perform the calculation with a triangular fiber section
- to change the accuracy of the calculation (recommended value 15, to be increased in the case of very thin parts)
- delete the calculation cache, which is useful when changing reinforcement materials or bars to prevent the program from returning the same results as before when these materials were changed
- export images of the analysed section or points of the resisting domain
- export the section to DXF with the reinforcement
- display the domain in 3D.

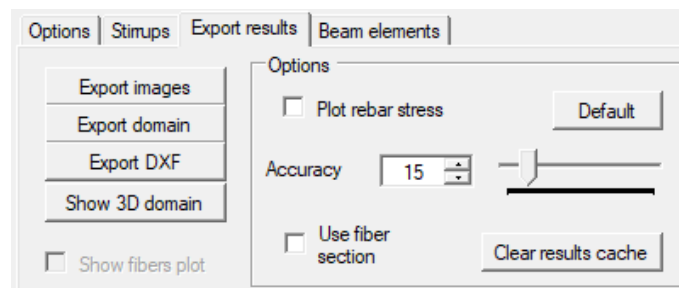

Beam elements allows the import of reinforcements from individual elements, temporarily overwriting those of the section. The *Get forces* button allows the stresses for the desired abscissa taken from the calculated model.

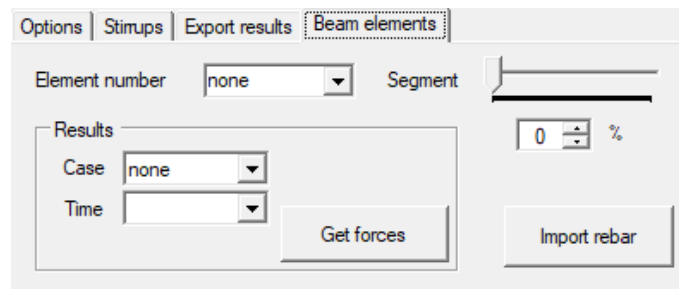

Checking FRP reinforcements in concrete sections

The verifications of the sections in c.a. reinforced with carbon fiber polymers (FRP) tapes are described below. The calculation procedure refers to the following Italian standards:

- CNR-DT 200 R1 / 2013 - Instructions for the Design, Execution and Control of Static Consolidation Interventions through the use of Fiber-reinforced Composites - Materials, reinforced concrete structures and of c.a.p., masonry structures;
- Guidelines for the Design, Execution and Testing of Reinforcement Interventions of reinforced concrete structures and masonry through FRP - Document approved on July 24, 2009 by the General Assembly of the Superior Council LL PP.

With reference to the CNR-DT200, the resistance of the FRP tape at the ultimate limit state is assumed to be the minimum between:

- Resistance due to detachment of ends, evaluated with the expression:

$$f_{\text{fdd}} = \frac{1}{\gamma_{\text{fd}}} \cdot \sqrt{\frac{2 \cdot E_f \cdot \Gamma_{\text{Fd}}}{t_f}}, \quad (4.4)$$

in which the specific fracture energy is evaluated as:

$$\Gamma_{\text{Fd}} = \frac{k_b \cdot k_G}{FC} \cdot \sqrt{f_{\text{cm}} \cdot f_{\text{ctm}}}. \quad (4.2)$$

- Resistance for intermediate detachment, evaluated as:

$$f_{\text{fdd},2} = \frac{k_q}{\gamma_{\text{fd}}} \cdot \sqrt{\frac{E_f}{t_f} \cdot \frac{2 \cdot k_b \cdot k_{G,2}}{FC} \cdot \sqrt{f_{\text{cm}} \cdot f_{\text{ctm}}}}, \quad (4.6)$$

Flexural reinforcement with FRP

It is assumed an ultimate deformation equal to the minimum between the maximum declared by the manufacturer (multiplied by η_A / γ_f) and:

$$\varepsilon_{\text{fdd}} = \frac{f_{\text{fdd},2}}{E_f} \geq \varepsilon_{\text{sy}} - \varepsilon_0, \quad (4.7)$$

As output, the program reports the maximum tension that can be absorbed by the tape, the fracture energy and the minimum anchor length, obtained from the relationship:

$$l_{\text{ed}} = \max \left\{ \frac{1}{\gamma_{\text{Rd}} \cdot f_{\text{bd}}} \sqrt{\frac{\pi^2 \cdot E_f \cdot t_f \cdot \Gamma_{\text{Fd}}}{2}}, 200 \text{ mm} \right\}, \quad (4.1)$$

in which $f_{\text{bd}} = \frac{2 \cdot \Gamma_{\text{Fd}}}{s_u}$, con $s_u = 0.25 \text{ mm}$ and $\gamma_{\text{Rd}} = 1.25$.

Shear reinforcement with FRP

Shear reinforcement is triggered when the following quantities are defined for a section:

Requested data	
Shear strip width	200
Shear strip spacing	200
Shear strip angle [°]	90
Shear strip material	2»UNI-AX HM 600
Shear strip thickness [mm]	0.337
Shear strip height	400
Confinement strip spacing	-1
OK	

- the Shear strip width (bf) is the width of the reinforcing composite strip applied to the section as U-shape, like in the following figure.

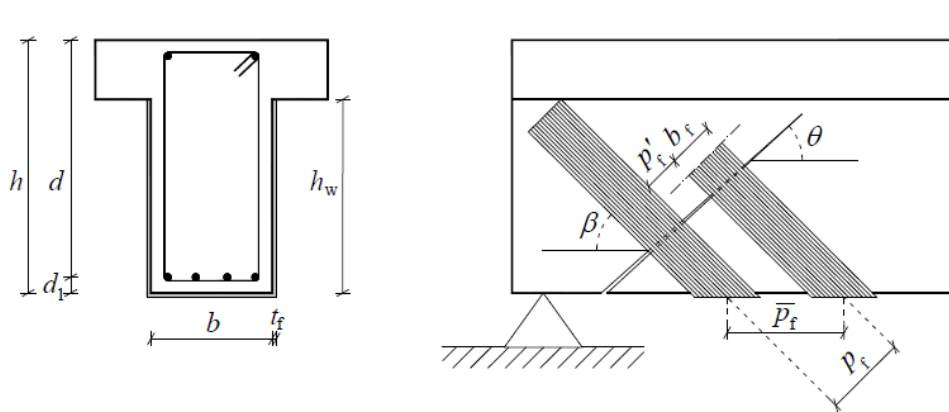

- the spacing pf between strips
- β angle in degrees, with respect to horizontal
- FRP material, chosen amongst the design materials
- the thickness of the strip tf, always defined in mm
- the height of the strip on the section edge. If this last quantity is 0, shear reinforcement is not triggered.

Hence, the effective strength of strip is evaluated as:

$$f_{fed} = f_{fdd} \cdot \left[1 - \frac{1}{3} \cdot \frac{l_{ed} \cdot \sin \beta}{\min \{0.9 \cdot d, h_w\}} \right]$$

assuming fdd as the previous (4.4).

In case of rectangular section, the shear contribution to be summed to the steel shear strength is:

$$V_{Rdf} = \frac{1}{\gamma_{Rd}} \cdot 0.9 \cdot d \cdot f_{fed} \cdot 2 \cdot t_f \cdot (\cot \theta + \cot \beta) \cdot \frac{b_f}{p_f}$$

while for circular sections is:

$$V_{Rdf} = \frac{1}{\gamma_{Rd}} \cdot D \cdot f_{fed} \cdot \frac{\pi}{2} \cdot t_f \cdot \cot \theta$$

Confining with FRP

Confinement is activated in a section or beam segment if the property "Confinement **spacing**" (pf) is greater than -1. pf=0 represents continuous confinement, while pf>0 represents discrete confinement as in the following figure.

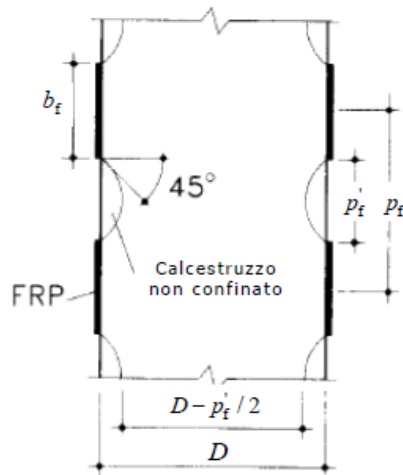

Confinement is only supported for rectangular and circular sections and the radius of curvature r_c is assumed to be at least 20mm. The effective confining pressure is evaluated as:

$$f_{l,eff} = k_H k_V k_\alpha \frac{1}{2} \rho_f \cdot E_f \cdot \varepsilon_{f,rid}$$

with $k_\alpha = 1$ assuming FRP fibers always orthogonal to the beam axis.

$$\varepsilon_{f,rid} = \eta_a \cdot \frac{\varepsilon_{fk}}{\gamma_f} \leq 0.6 \cdot \varepsilon_{fk}$$

Reduced strip deformation (with a limit of 0.004):

$$k_V = \left(1 - \frac{p'_f}{2 \cdot d_{min}} \right)^2$$

Vertical efficiency factor:

For circular sections:

$$\rho_f = \frac{4 \cdot t_f \cdot b_f}{D \cdot p_f}$$

- geometric percentage of reinforcement:

- $k_H = 1$

For rectangular sections:

$$\rho_f = \frac{2 \cdot t_f \cdot (b + h) \cdot b_f}{b \cdot h \cdot p_f}$$

- geometric percentage of reinforcement:

$$k_H = 1 - \frac{b^2 + h^2}{3 \cdot A_g}$$

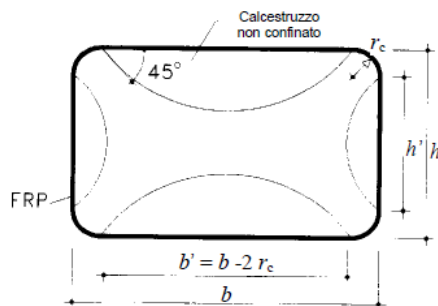

$$\frac{f_{ccd}}{f_{cd}} = 1 + 2.6 \cdot \left(\frac{f_{l,eff}}{f_{cd}} \right)^{2/3}$$

The increase in strength of confined concrete is equal to:

$$\text{The ductility increase of confined concrete is equal to: } \Delta \varepsilon = 0.015 \sqrt{\frac{f_{l,eff}}{f_{cm}}}$$

Flexural reinforcement with FRCM

The design strength of the strip is given by:

$$f_{lim,d} = \alpha \cdot \eta_A \cdot \frac{f_{lim}}{\gamma_f}$$

The sectional calculation is carried out in the same way as for FRP.

Shear reinforcement with FRCM

With the same symbolism adopted for FRP:

$$f_{fed} = \begin{cases} \sigma_{fd} \frac{L_{max}}{l_{ed}} \left(1 - \frac{1}{3} \frac{L_{max}}{l_{ed}} \right) & \text{se } L_{max} \leq l_{ed} \\ \sigma_{fd} \left(1 - \frac{1}{3} \frac{l_{ed}}{L_{max}} \right) & \text{se } L_{max} > l_{ed} \end{cases} \quad \text{con } L_{max} = \frac{\min\{0.9 \cdot d, h_w\}}{\sin \beta}$$

$$V_{Rdf} = \frac{1}{\gamma_{Rd}} \cdot 0.9 \cdot d \cdot f_{fed} \cdot 2 \cdot t_f \cdot (\cot \theta + \cot \beta) \cdot \frac{b_t}{p_f} \cdot \sin^2 \beta$$

Confinement with FRCM

The confinement is only activated if the pf step is ≥ 0 . It is also necessary that the characteristics of the FRCM material used contain the compressive strength of the matrix $f_{c,mat}$.

The effective confining pressure is calculated as:

$$f_{l,eff} = 2k_H \frac{t_f}{S_{max}} E_f \cdot \varepsilon_{fd,rid}$$

$$\varepsilon_{fd,rid} = \min \left(k_{mat} \eta_A \cdot \frac{\varepsilon_{fu}}{\gamma_f}, 0.004, 0.6 \varepsilon_{fu} \right) \quad \text{with } S_{max} = D \text{ for circular section, } S_{max} = \max(b, h) \text{ otherwise}$$

We then assume t_f as the total thickness of the reinforcement strips.

$$k_{mat} = 0.217 \cdot \left(\rho_{mat} \cdot \frac{f_{c,mat}}{f_{cd}} \right)^{3/2} \leq 1$$

$$\frac{f_{ccd}}{f_{cd}} = 1 + 2.6 \cdot \left(\frac{f_{1,eff}}{f_{cd}} \right)^{2/3}$$

The increase in strength of confined concrete is equal to:

$$\text{The ductility increase of confined concrete is equal to: } \Delta \varepsilon = 0.015 \sqrt{\frac{f_{1,eff}}{f_{cm}}}$$

Error codes

- 0 ok
- 2 material for bars missing
- 3 incorrect bar material (missing design deformations)
- 4 stress exceeds maximum tension
- 5 stress exceeds maximum compression
- 6 (only in case of elastic analysis) N=0, analysis not possible in absence of stresses
- 7 (only in the case of elastic analysis) elastic analysis does not converge
- 8 material not set for a solid or hollow figure in section
- 9 (only for timber material) characteristic bending stress fmk missing
- 10 (only for confined sections) brackets not set
- 11 (only for steel-clc composite sections) wrong base material for composite section
(wood thermal analysis only) wrong cross-section shape - rectangular and circular cross-sections
- 12 only
- 13 (only for steel-clc composite sections) missing material for section part
- 15 resistance fk of material not set
- 16 (only for calculation with concrete also tensile) material resistance ftk not set
- 17 deformation e_c2 missing
- 18 Deformation e_c3 missing
- 19 deformation e_cu missing
- 20 (only for FRP sections) impossible to continue calculation, EpsU<EpsSy-Eps0 (4.7 CNR DT 200)
- 21 meshing not succeeded (don't use FRP strips in meshed sections)

License Terms

END USER LICENSE AGREEMENT

By using the software provided by NextFEM SRLS, user explicitly agreed to the following terms and conditions. The contents of NextFEM website and of the supplied software, including the following license terms, could be changes and/or updated at any time. By using the software supplied by NextFEM SRLS or our website, the privacy policy of NextFEM SRLS, published on <https://www.nextfem.it/it/privacy-policy/>, is accepted.

Art. 1 – User license –

1. On the basis of the following terms and conditions, NextFEM SRLS, in the person of its in office pro tempore legal representative (specified as “Company” or “Licensor” in the following), grants to the Customer (“User” or “Licensee” in the following) the license to use the software (or “Program” or “Programs” in the following) provided by NextFEM SRLS, for PC and for Windows® operating system, including manuals and documentation. The license hereby granted is not exclusive and not transferable in any case.

2. The present agreement does not transfer to the Licensee the source code of the supplied software, neither the logic and/or design documentation.

Art. 2 – Duration – Agreement termination –

1. The present agreement is valid for one year, starting from the license issue date. At the end of the year, this agreement will be considered automatically rescinded, unless a renewal request by the Customer is received by NextFEM SRLS via email at licensing@nextfem.it at least 30 days before the license expiration, or unless the Customer buys the renewal. Different conditions may apply for Educational licenses.

2. NextFEM SRLS has the right to terminate earlier the present agreement due to gross negligence or wilful misconduct of the Customer and/or for violations of the present agreement. Termination will be communicated via email to the address supplied by the Customer during registration onto the Company’s website. In any case, the Licensor has the right to the compensation for damage.

Art. 3 - License delivery -

1. The free software provided by NextFEM SRLS which is freely available can be independently downloaded by the Customer from the site nextfem.it.

2. The paid software provided by NextFEM SRLS which is subjected to a fee can be independently downloaded by the Customer from the site nextfem.it. License request are fulfilled by the Licensor in the indicative and not binding term of 7 days after the reception of the payment. Different conditions may apply for Educational licenses.

3. In any case, NextFEM SRLS is not responsible of any damage directly or indirectly connected to delays not dependent on its will during the release of the license.

Art. 4 – Installation -

1. NextFEM software is auto-installing. Once the installation is performed, the software is considered as accepted by the Customer.

2. Any other service (e.g. installation, verification, assistance requested by the Customer to let his employees to use NextFEM software) will be performed by NextFEM SRLS after a Customer’s request and in any case after a quotation made by NextFEM Srls and its acceptance by the Customer.

3. The Customer is solely responsible that his technological equipment (hardware and software) meets the minimum and essential requirements to install and use the software, as indicated in the users’ manual included in the program.

Art. 5 – Programs usage –

1. The Customer must use NextFEM software for lawful and legal purposes.

2. The Customer undertakes to not remove or alter any trademarks, serial number or other information related to right reservation, which are included in software produced by NextFEM SRLS, even after the termination of the present agreement.

3. According to the Italian law art. 64 ter Law 22nd of April 1941, n. 633 as amended and supplemented and art. 5 par. 2 Directive 2009/24/EC of the European Parliament and of the Council of 23 April 2009 as amended and supplemented, it is allowed to the Licensee Customer, having the right to use a copy of the software produced by NextFEM SRLS, to make a back-up copy of the software and of the included documentation, so far as it is necessary for that use.

4. According to the Italian law art. 64 bis, lett. a) and b) ,64 ter Law 22nd of April 1941, n. 633 as amended and supplemented and art. 4 par. 1 lett. a) and b) Directive 2009/24/EC of the European Parliament and of the Council of 23 April 2009 as amended and supplemented, it is explicitly forbidden to the Customer the permanent or temporary reproduction of the software produced by NextFEM SRLS and of the included documentation, by any means and in any form, in part or in whole, without the authorisation by the right-holder. In so far as loading, displaying, running, transmission or storage of the aforementioned software necessitate such reproduction, even such acts shall be subject to authorisation by the right-holder. At the same conditions and with the same restrictions, it is equally forbidden to the Customer the translation, adaptation, arrangement and any other alteration of the software produced by NextFEM SRLS and of the included documentation and the reproduction of the results thereof, without prejudice to the rights of the person who alters the program.

5. The acts of the aforementioned paragraphs 2 and 3, even when they are necessary for the use of the aforementioned software by the lawful Licensee Customer in accordance with its intended purpose, including for error correction, are subjected to the authorisation by the right-holder.

6. According to the Italian law art. 64 ter, subparagraph 3 Law 22nd of April 1941, n. 633 as amended and supplemented and art. 5 par. 3 Directive 2009/24/EC of the European Parliament and of the Council of 23 April 2009 as amended and supplemented, it is allowed to the Licensee Customer to observe, study or test the functioning of the software produced by NextFEM SRLS and of which he holds the License, in order to determine the ideas and principles which underlie any element of the program if he does so while performing any of the acts of loading, displaying, running, transmitting or storing the program which he is entitled to do.

7. According to the Italian law art. 64 quater Law 22nd of April 1941, n. 633 as amended and supplemented and art. 6 Directive 2009/24/EC of the European Parliament and of the Council of 23 April 2009 as amended and supplemented, the previous authorisation of NextFEM SRLS shall not be required where reproduction of the code and translation of its form within the meaning of art. 64bis, lett. a) and b) Law 22nd of April 1941, n. 633 as amended and supplemented and of points (a) and (b) of Article 4 par.1 are done to modify the form of the code and are indispensable to obtain the information necessary to achieve the interoperability of an independently created computer program with other programs, provided that the following conditions are met:

(a) those acts are performed by the Licensee or by another person having a right to use a copy of a program, or on their behalf by a person authorised to do so;

(b) the information necessary to achieve interoperability has not previously been readily available to the persons referred to in point (a);

(c) those acts are confined to the parts of the original program which are necessary in order to achieve interoperability.

8. The provisions of preceding paragraph 7 shall not permit the information obtained through its application:

(a) to be used for goals other than to achieve the interoperability of the independently created computer program;

(b) to be given to others, except when necessary for the interoperability of the independently created computer program;

(c) to be used for the development, production or marketing of a computer program substantially similar in its expression, or for any other act which infringes copyright.

9. In accordance with the provisions of the Berne Convention for the protection of Literary and Artistic Works, enacted in Italy with the Italian law 20th of June 1978, n. 399 as amended and supplemented, the provisions of article 64 quater Law 22nd of April 1941, n. 633 as amended and supplemented and art. 6 of Directive 2009/24/EC of the European Parliament and of the Council of 23rd April 2009 as amended and supplemented may not be interpreted in such a way as to allow its application to be used in a manner which unreasonably prejudices the right-holder's legitimate interests or conflicts with a normal exploitation of the computer program.

Art. 6 – Property – Transfer prohibition –

1. The software provided by NextFEM SRLS and the included documentation remain exclusive property of NextFEM SRLS. The Customer is explicitly forbidden to distribute products of NextFEM SRLS or copies to anyone or to sell them or assign them in license to third parts or to lease them, or in any case to allow others to use the programs, either in exchange for payment or not. In these cases, NextFEM SRLS can revoke the user's license of the free program or of any of the paid modules at any time.

2. This clause will remain in force even after the rescission or the termination to any title of this contract.

Art. 7 – Right holders – Secret – Modifications –

1. The software provided by NextFEM SRLS, the included documentation, the program code, its layout, the structures and the program files organization, the program name, the Company logo and any other representation form within the software are subjected to copyright; this one, and any rights coming from it or in any way connected to the copyright are property of NextFEM SRLS. Other trademarks belong to the respective owners.

2. The Customer is required to keep secret the content of the software provided by NextFEM SRLS and the included documentation, **and to protect NextFEM SRLS and his suppliers' rights; in particular, the Customer is required either to make no modifications** to the software provided by NextFEM SRLS or to incorporate it entirely or in part in other software without preventive written

authorisation by NextFEM SRLS, without prejudice to current mandatory legislation on the matter. In these cases, NextFEM SRLS can revoke the user's license of the free program or of any of the paid module at any time.

3. This clause will remain in force even after the termination or the expiration in whatever manner of this agreement.

Art. 8 – Fee – Solve et repete –

1. NextFEM SRLS provides the software “as is” and is not obliged to provide maintenance, support, updates, improvements or changes. Different conditions may apply to paid software and for Education licenses.

2. To ensure the continuity of the license and of paid modules, the Customer must pay the relative fee at least 15 days before the **current license expires; if the deadline is not respected, NextFEM SRLS can't guarantee such continuity, and the licensed modules** may be blocked. For no reason the payment of the annual fee regarding the software and/or its single component module and/or required services can be delayed or suspended; eventual exceptions or Customer's disputes will be managed and solved separately.

3. NextFEM SRLS provides software updates for 12 (twelve) months starting from the delivery date, limited to the functionalities of paid module/s. During this period, encountered malfunctions in paid modules will be fixed to ensure the correct functionality. This guarantee does not apply to functionalities not included in the paid modules.

Art. 9 – Warranty and liability –

1. For both the basic software version and the paid modules, NextFEM SRLS provides the software “as is” and it is not obliged to provide maintenance, support, updates, improvements or changes. During the validity of this agreement, eventual software updates or patches may be released.

2. NextFEM SRLS is committed, only for functionalities of the paid modules, and for 12 months from the purchase, to keep the software able to perform the tasks described in the user manual. During this period, encountered malfunctions of the paid modules will be fixed to ensure the correct functionality. This guarantee does not apply to functionalities not included in paid modules, nor to Educational licenses, as stated in art. 14 of this agreement.

3. The warranty is conditioned to the correct original functioning of the Client's machine, hardware and system software and the existence of the minimum requirements prescribed for the correct software installation, as well to the circumstances in which the Customer installs the updates and patches that can be made available by the Licensor via an independent download made from the nextfem.it website, and also to the correct use of the system and software by the Customer.

4. The Customer is the sole responsible for the choice of the software produced by NextFEM SRLS and its compliance to his own needs and purpose of use, for any input fed to the software and any output coming from the program or from its parts, and must verify results, reports and the checks conducted with it.

5. The software provided by NextFEM SRLS are a representation of the current state of development, so NextFEM SRLS cannot grant that they will always work correctly in every applications and in any situation.

6. Customer is responsible of installation, launch, and usage of the software produced by NextFEM SRLS and of the application of the related updates and patches, their transfer to the computer, the settings, and everything not explicitly stated in this Contract that burden on NextFEM SRLS.

7. This warranty is not valid whenever a software fault is due to accident, improper and/or non-conforming and/or wrongful usage. Any change to the software made directly by the Customer will result in the withdrawal of this warranty.

8. NextFEM SRLS does not take any responsibility and is not liable for any direct and/or indirect, special, collateral, incidental and/or consequential damage, including lost profits, incurred by the Customer or third parts caused through the use or lack of use of the software and by any means related and/or consequential to eventual software quality, adequacy, use and usability flaws, which are therefore to be exclusively borne by the Customer, except as what is compulsorily required by law.

9. NextFEM SRLS does not take any responsibility and is not liable for any direct and/or indirect, special, collateral, incidental and/or consequential damage, including lost profits, incurred by the Customer or third parts caused through the use or lack of use of the software and by any means related and/or consequential to eventual software quality, adequacy, use and usability, caused by suppliers or by parts of program developed by third parts. To these parts of programs developed by third parts are applied their own licensing conditions, which can be found inside NextFEM SRLS software from **? / Information ...**

Art. 10 – Software restitution - Software deletion –

1. Within one month from the termination of this agreement for any reason, the Customer must delete and eliminate any copy of the software he owns, even if they are backup copies. The Customer must confirm this by sending to NextFEM SRLS an e-mail within the same deadline.

2. As a consequence of the termination of this agreement as in the previous subparagraph, the license of use is revoked and cannot be use anymore by the Customer for any purpose.

Art. 11 – Support and/or consultation -

1. Upon Customer's request, NextFEM SRLS is willing to give, by a preventive stipulation of specific separate contracts, the necessary support and/or consultation to maintain or launch or update or personalize or implement the software provided by NextFEM SRLS, also for a potential training of Customer's staff who is appointed for its use.
2. The possible existence of other contractual relationships between NextFEM SRLS and the Customer does not affect other connections between them, that will remain separated and independent.
3. The free licenses of use granted by NextFEM SRLS (i.e. basic program, Educational license, etc.) are not covered by any kind of support.
4. The paid licenses of use granted by NextFEM SRLS to the Customer can be issued with a first-installation assistance via email, until 7 days after the payment. Further paid support can be supplied for one year starting from the license acquisition. Support period can be bought or renewed only together with the program license or renewal, respectively. Assistance is supplied only via email and concerns the sole software use or program functioning. NextFEM SRLS does not supply support on the engineering choices made or to be made for designing any structures. Any advice given by support cannot substitute the engineering judgement of the Customer, who is the sole responsible of the structure designed, analysed and checked with the program, including the obtained results.

Art. 12 – Communication -

1. Any communication from one part to another of this agreement must be sent as a registered letter with signed return receipt or as a **hand-delivered registered letter addresses to "NextFEM SRLS, Piazza del Foro Romano 12, 31046 Oderzo (TV)" or as a certified e-mail to nextfem@pec.nextfem.it.**

Art. 13 – Litigation – Applied law -

1. This contract is subjected to the Italian law.
2. Any litigation in any case connected to this agreement shall be exclusively of the competence of the Court of Treviso.

Art. 14 – Educational license –

1. Educational licenses are distributed for a predetermined number of PCs prior oral or written agreement with NextFEM SRLS. NextFEM SRLS solely decides the number of distributed licenses prior consultation with the Customer.
2. Educational licenses can be given freely to a private or public Customer, when it is a training institution, a research and development company or a school, at the incontestable discretion of NextFEM SRLS. In such case, the given Educational licenses do not grant to the Customer the right to use them after the planned time period conceded to the Licensee, and they can be revoked at any time by NextFEM SRLS without any justification or notice to the Customer.
3. When given freely, Educational license does not allow for any refund of the cost of the software, for any reason.
4. When given freely, Educational license does not allow for any kind of support supplied by NextFEM SRLS, neither for malfunctioning of the program. Hence, the warranties described in art. 9, paragraph 2 of this agreement are excluded.

Art. 15 – Changes of terms in this agreement –

1. **The Licensor has the right to modify the conditions of the present License user's agreement for the software of NextFEM SRLS** by email to be sent to the Licensee to the address given during registration on nextfem.it website. The Licensee has the right of withdrawal by sending a registered letter with signed return receipt or as a **hand-delivered registered letter addresses to "NextFEM SRLS, Piazza del Foro Romano 12, 31046 Oderzo (TV)" or as a certified e-mail to nextfem@pec.nextfem.it** compulsorily within 14 days from the receipt of the communication related to the changes of the agreement terms.

Art. 16 – Final provisions -

1. Whenever one of the clauses contained in this Contract will be declared invalid or without effects, entirely or in part, this will not invalidate the other clauses, except when the Licensor considers in bona fide the clause as essential, and consequently shall ask for the resolution of the contract.
2. For anything not expressly provided in this contract, the Italian Civil Code rules shall be applied and the Legislative Decree of 29th of December 1992, n. 518 as amended and supplemented, regarding the implementation of the Council Directive n. 91/250 CEE of 14th of May 1991 on the legal protection of computer programs which modifies and integrates Law 22nd of April 1941, n. 633, and this last law as amended and supplemented, and the Directive 2009/24/EC of the European Parliament and the Council of 23rd of April 2009 as amended and supplemented.

Oderzo (TV), (date of acceptance of this contractual conditions)

NextFEM SRLS

Licensee

Pursuant to and in accordance with art. 1341 and 1342 c.c., the Customer specifically approves, for having them read, understood and known, the articles: 2 (Duration – Agreement termination) paragraph 2, 3 (License delivery) paragraph 3, 4 (Installation) paragraph 3, 5 (Programs usage), 6 (Property – Transfer prohibition), 7 (Right holders – Secret – Modifications) paragraph 2, 8 (Fee – Solve et repete) paragraph 2, 9 (Warranty and liability) paragraphs 3,4,5,6,7,8,9, 10 (Software restitution - Software deletion) paragraph 4, 11 (Support and/or consultation), 13 (Litigation – Applied law), 14 (Educational license) paragraphs 2 and 3, 15 (Changes of terms in this agreement), 16 (Final provisions).

Oderzo (TV), (date of acceptance of this contractual conditions)

The Customer

This software is copyright of NextFEM, 2014-2019.

Windows® is a registered trademark of Microsoft Corporation. Other trademarks belong to their respective owners.

All the licenses, including the general one for the program and for paid modules, can be found in the dialog *?/About*

....